

Wiring example for Base unit

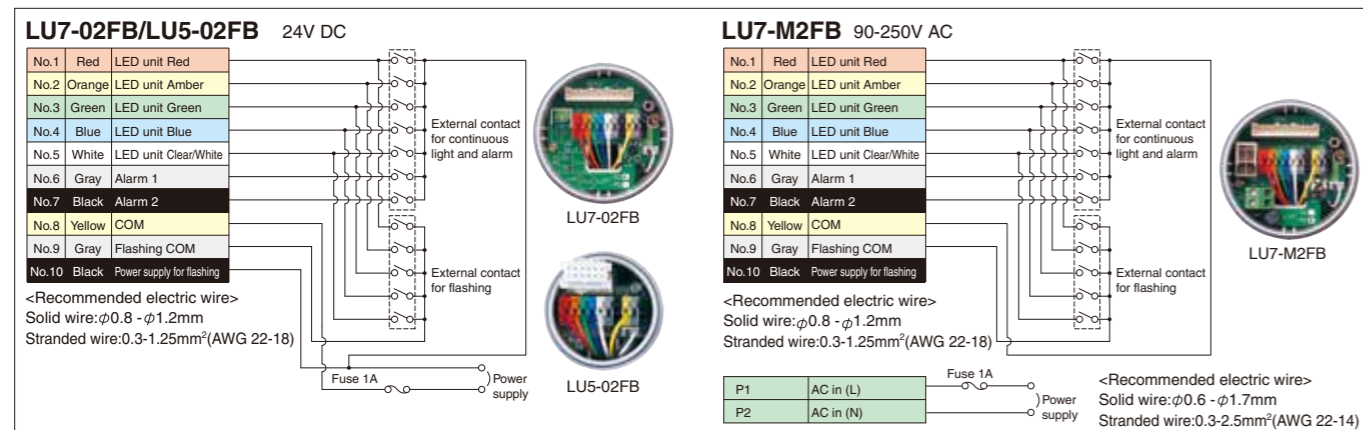

【External contact capacity】

Voltage specs		24V DC	90~250V AC
LED unit	Current consumption	Red · Amber : 52mA Green · Blue · Clear/White : 42mA	
[1-Light]	Contact capacity	$I_s \geq 100\text{mA}$, $V_s \geq 35\text{V AC}$	
	Current consumption	50mA	
Alarm	Inrush current	100mA	
	Contact capacity	$I_s \geq 100\text{mA}$, $V_s \geq 35\text{V AC}$	
Power supply	Current consumption	360mA	40mA (250V) ~ 110mA (90V)
	Contact capacity	$I_s \geq 500\text{mA}$ $V_s \geq 35\text{V AC}$	9A (90V) ~ 25A (250V) $V_s \geq 250\text{V AC}$

※ I_s : Current capacity V_s : Withstand voltage

【External contact fuse】

Voltage	Amperage rating of fuse
All model	250V 1A

※ Use a fuse conforming to the rated current of the machine on which you install product.
(Example: UL class J type fuse)

Dimensions

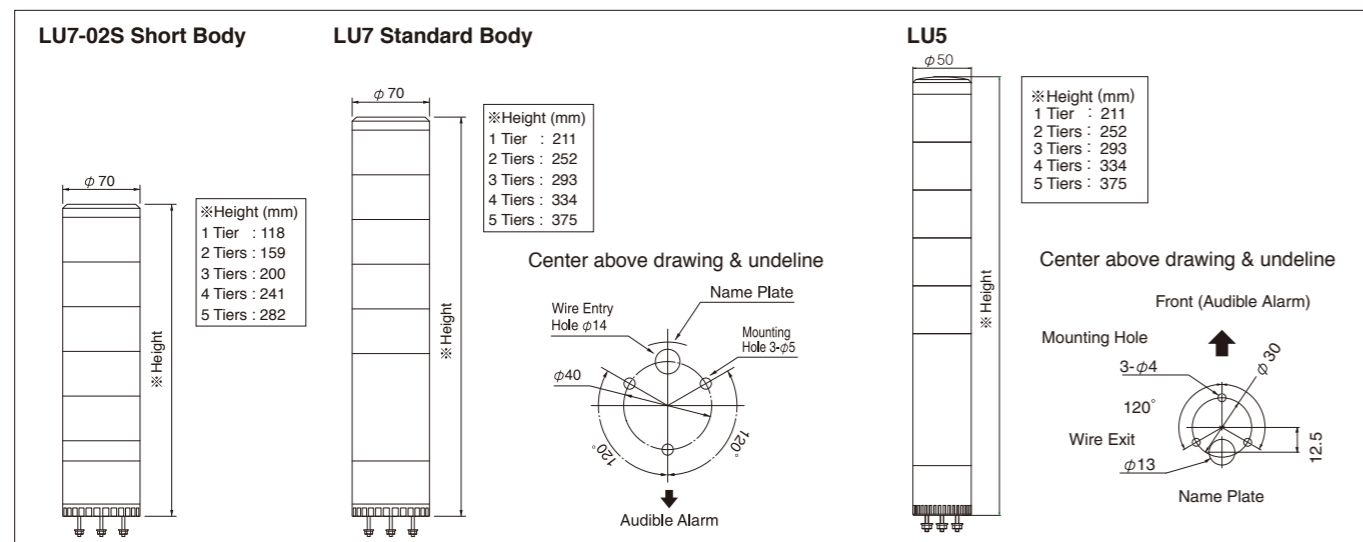

PATLITE Corporation

4-4-25 Honmachi Chuo-ku Osaka 551-0053 Japan TEL.+81-6-7711-8953 FAX.+81-6-7711-8961

PATLITE (U.S.A.) Corporation
20130 S. Western Ave., Torrance, CA 90501, U.S.A. TEL.+1-310-328-3222 FAX.+1-310-328-2676

PATLITE Europe GmbH
Am Soeldnermoos 8, D-85399 Hallbergmoos, Germany TEL.+49-811-9981-9770-0 FAX.+49-811-9981-9770-9

PATLITE (SINGAPORE) PTE LTD
No.2 Leng Kee Road, #05-01 Thye Hong Centre, Singapore 159086 TEL.+65-6226-1111 FAX.+65-6324-1411

PATLITE (CHINA) Corporation
Post Code: 200072 Room 1102-1103 No.55, Lane 777, Guangzhong Road (West), Zhabei District, Shanghai, China TEL.+86-21-66308969 FAX.+86-21-66308938

PATLITE KOREA CO., LTD.
A-2603, Daesung D-POLIS, 543-1 Gasan-dong, Geumcheon-gu, Seoul, 153-719 TEL.+82-2-523-6636 FAX.+82-2-861-9919

PATLITE TAIWAN CO., LTD.
7F, No. 91, Huayin St, Datong District Taipei, Taiwan R.O.C TEL.+886-2-2555-1611 FAX.+886-2-2555-1621



ISO14001:2004 Certified
Headquarters/Sanda Plant/Techno Center

CAUTION To ensure correct use of these products, read the Instruction Manual prior to use. Failure to follow all safeguards can result in fire, electric shock, or other accidents. Specifications are subject to change without notice.

<http://www.patlite.com> E-mail: overseas@patlite.co.jp



For the benefit of mankind and the earth, Patlite is committed to developing environmentally friendly products.



0-3106C EN 1509 A

PATLITE®

New Frontiers for Safety, Security and Comfort.

Modular LED Signal Tower LU5/LU7 Series



LU5 Series
50mm dia.

LU7 Series
70mm dia.

PATLITE Corporation

LU5 Series

50mm diameter

Modular LED Signal Tower

LED Units

Model	LU5-E-R	LU5-E-Y	LU5-E-G	LU5-E-B	LU5-E-C
Unit Color					
Rated Voltage	DC 24V				
Operating Voltage Range	DC 21.6 ~ 26.4V				
Current/Power Consumption	52mA/1.25W		42mA/1.0W		
Operating Temperature Range	-30°C ~ +60°C				
Mass (±10%)	44g				

RED AMBER GREEN BLUE CLEAR/WHITE



LU5-E-R
LED unit RED



LU5-E-Y
LED unit AMBER



LU5-E-G
LED unit GREEN



LU5-E-B
LED unit BLUE



LU5-E-C
LED unit CLEAR/WHITE

BASE Units

Model	LU5-02	LU5-02FB
Color		
Body Style	Standard	
Rated Voltage	DC 24V	
Operating Voltage Range	DC 21.6 ~ 26.4V	
Alarm		*Alarm 1 **Alarm 2
Current Consumption		50±10mA 24±10mA
Power Consumption		1.2±0.25W 0.58±0.25W
Sound Level	Max: 85±5dB (at 1m)	
Flashing Cycle	60±12 flasher per minute	
Operating Temperature Range	-30°C ~ +60°C	
Mounting Direction	Upright, indoor only	
Protection Rating	IP65	
Mass (±10%)	182g	200g
Open Collector	PNP/NPN	

* Alarm 1 : Continuous Sound **Alarm 2 : Intermittent Sound

Unit Color Variation

Ivory White **Silver** **Black**



Ivory White LU5-02+ROHS1
LU5-02FB+ROHS1
Silver LU5-02U+FB150
LU5-02UFB+FB150
Black LU5-02+FB200
LU5-02FB+FB200

Pre-assembled

SZ-22Q+O0103

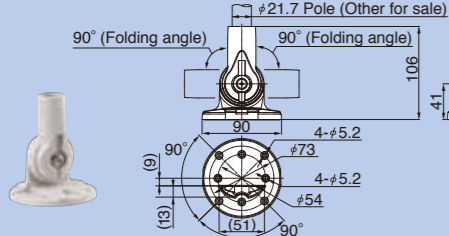

SZ-60T

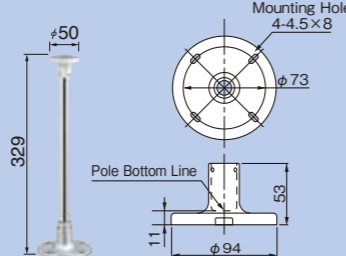

SZ-60L

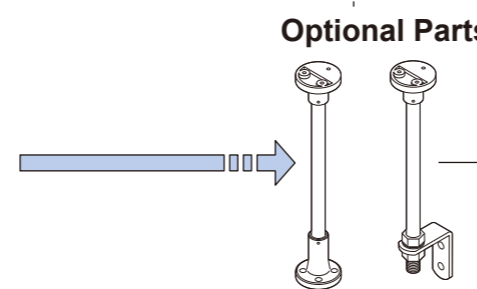
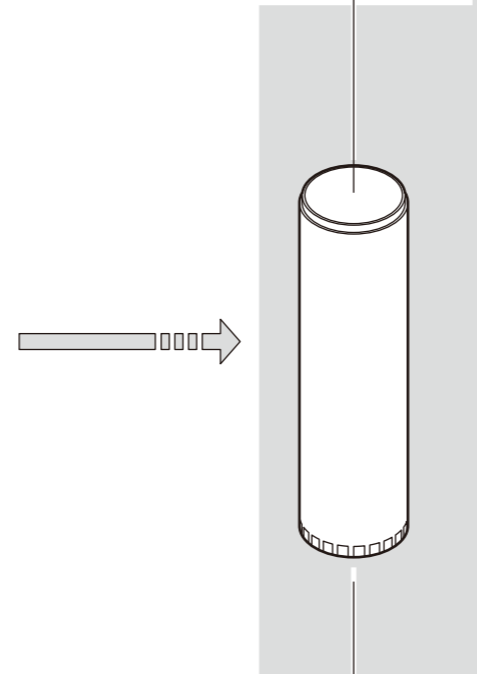
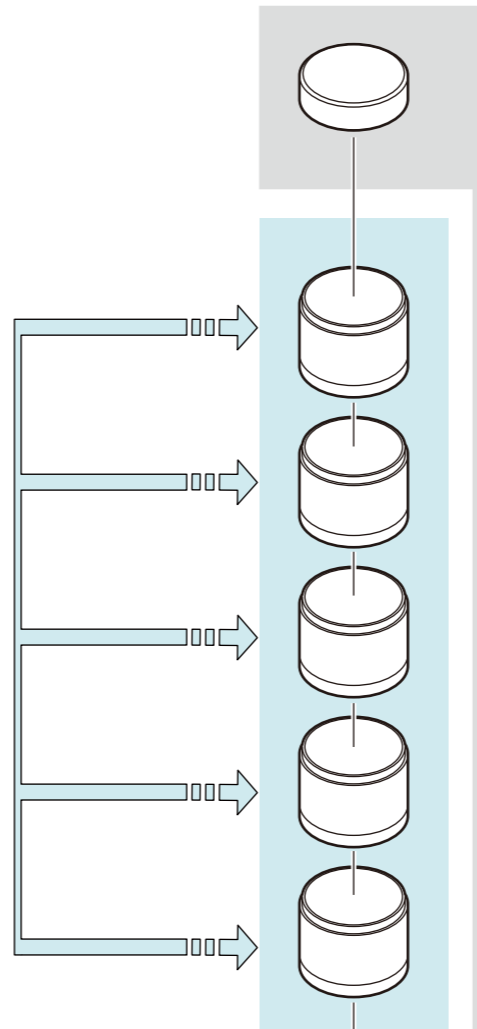
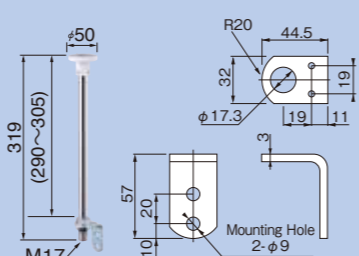

Optional Parts



US LISTED

IP65 Environment Protection

Upper Bracket

SZ-60-U (For φ21.7mm Pole)

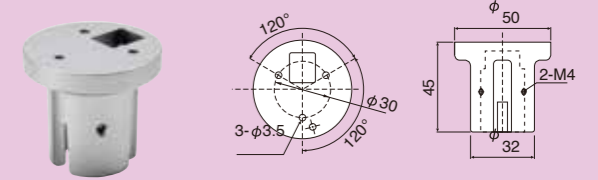

Upper Bracket

SZ-60NPT (For 1/2" NPT Pole)

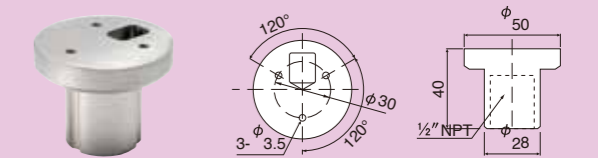

Pole

Steel Pole

800mm : POLE-800S21
300mm : POLE-300S21
100mm : POLE-100S21

Aluminum Pole

800mm : POLE-800A21
800mm : POLE-800A21K*
300mm : POLE-300A21
300mm : POLE-300A21K*
100mm : POLE-100A21
100mm : POLE-100A21K*

* Black Pole

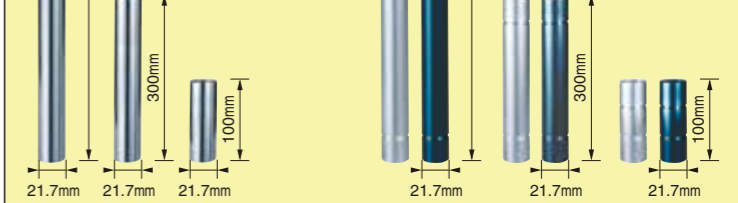

Mounting Bracket

SZ-016A
(For φ21.7mm Pole)



SZ-70-B
(For φ21.7mm Aluminum Pole Only)



Wall Mount Bracket

SZ-020
(For φ21.7mm Pole)



SZ-017
(For φ21.7mm Pole)

